

产品BOM表

NO.	产品名称	产品编码	数量	材质/表面处理
①	GL-BX2828K前盖-PBT白	99.02.73.207-Q1	1	PBT+15%GF/素材白
②	GL-BX2828K后盖-PBT白	99.02.73.207-H2	1	
③	COB免焊支架端子		2	t=0.25mm铜镀镍+加硬

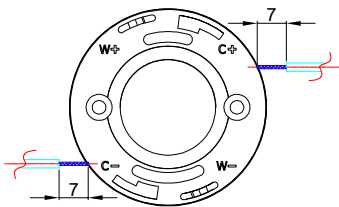
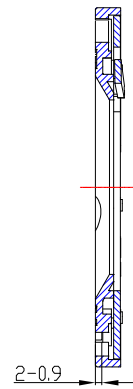
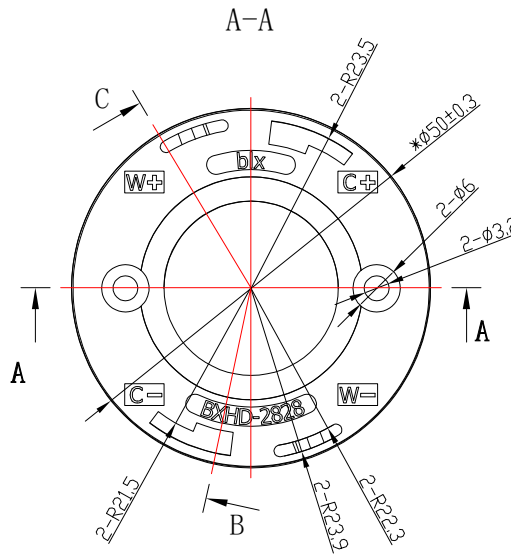
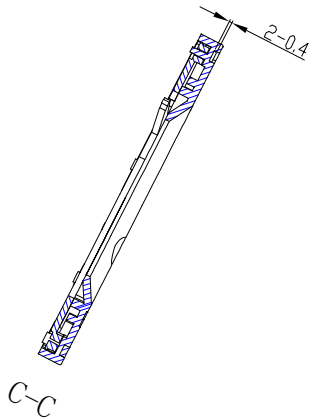
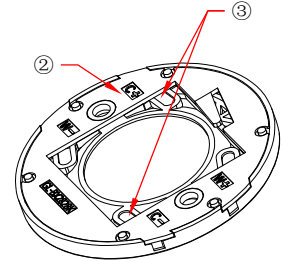
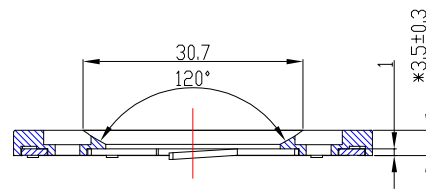
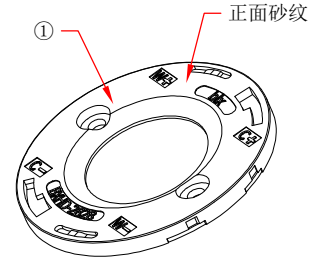
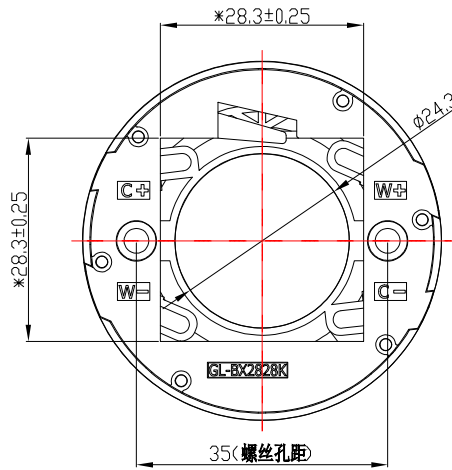

Wire specifications:  
0.32 mm<sup>2</sup> to 0.81 mm<sup>2</sup>.  
18AWG, 20AWG, 22AWG.  
Strip length: 7 mm. Surface tin-plated.

电线规格:  
0.32毫米<sup>2</sup>至0.81毫米<sup>2</sup>.  
18AWG, 20AWG, 22AWG.  
剥线长度7毫米, 表面镀锡。

技术要求:

1. 材质: 详见bom表。  
Material: Refer to the BOM table.
2. "\*" 标记为重点控制尺寸。  
The "\*" marked items are the key controlled dimensions.
3. 未注公差按GB/T14486-2008-MT6。  
The unmarked tolerances follow GB/T14486-2008-MT6.
4. 适配: V22, CLU 04X等基板规格为28×28的COB光源。  
Compatibility: V22, CLU 04X and other substrate specifications with a size of 19×19 for COB light source

								版本 VERSIONS
						K0-PL		
						产品编码 PRODUCT CODE	99.02.73.207	
						产品名称 PRODUCT NAME	COB2828K-L23光源免焊支架2线-PBT白Ø50H3.5	
						客户 CUSTOMER	NT	
标记 MARK	处数 NO. OF MODIF.	更改内容 MODIFICATIONS		签名 SIGNED BY	更改日期 MODIF. DATE	客户产品编号 CUSTOMER PRODUCT CODE		GL-BX2828K-2线
设计 DESIGNER	工艺 TECHNICIAN	制图 DRAWN BY	审核 CHECKED BY	比例 SCALE	视角 1ST ANGLE PROJECTION	单位 UNIT		mm
批准 APPROVED BY	日期 DATE (DD-MM-YYYY)	05-11-2025		页数 PAGE	SHEET 1 OF 1	产品图 PRODUCT DRAWING		